

MAKE THE MOST OF YOUR

LYNX



ASADO CARE & USE/INSTALLATION

WARNINGS



WARNING

- Never use dented, rusty or damaged propane cylinders. Never store additional or empty propane cylinders in the grill cabinet or in the vicinity of this or any other appliance. Do not store propane cylinders indoors or on their sides.
- Children should never be left alone or unattended in an area where a grill is located. Place your grill well away from areas where children play. Do not store items that may interest children in or around the grill, in the cart, or in the masonry enclosure.
- Never move the grill when hot. When in use, portions of the grill are hot enough to cause severe burns.
- Always maintain the required clearances from combustibles as detailed. The grill is designed for outdoor use only. Never use in a garage, building, shed, breezeway, or other enclosed area. Do not use this grill under any unprotected overhead combustible construction.
- Gas grills are not designed or certified for and are not to be installed in or on recreational vehicles, portable trailers, boats or any other moving installation.
- Always have an ABC Fire Extinguisher accessible - never attempt to extinguish a grease fire with water or other liquids.
- Storing your grill: Store your grill in a well-ventilated area. If stored indoors, detach and leave L.P. cylinder outdoors in a well-ventilated area away from heat and away from where children may tamper with it.
- Keep any electrical supply cord and the fuel supply hose away from any heated surfaces. Electrical cords should be placed away from walkways to avoid tripping hazard.
- Do not repair or replace any part of the grill unless specifically recommended in this manual. Other service should be performed by a qualified technician.
- If the grill is installed by a professional installer or technician, be sure that he/she shows you where your gas supply shut-off is located. All gas lines must have a shut-off that is readily and easily accessible. If you smell gas, check for gas leaks immediately. Check only with a soap and water solution. (See: "Leak Testing" for further details.) Never check for gas leaks with an open flame.
- Inspect the L.P. gas supply hose prior to each use of the grill. If there is evidence of excessive abrasion or wear, or the hose is cut, it must be replaced before using the grill.
- Never remove the grounding prong from the plug or use this product with an ungrounded, 2-prong adapter.

THIS MANUAL MUST REMAIN WITH THE PRODUCT OWNER FOR FUTURE REFERENCE.

This product complies with ANSI standard Z21.58/CSA 1.6 and has been tested and approved by Intertek.

To obtain replacement parts or service contact:

Lynx Professional Grills
62201 Hwy 82 West
Greenwood, MS 38930
888-289-5969

WARNINGS



WARNING

READ THIS MANUAL CAREFULLY and completely before using your grill to reduce the risk of:

1. Fire
2. Burn hazard, personal injury or property damage
3. Ruined steaks or other unpleasant cooking experiences
4. Unapproved installation or servicing.
5. THIS PRODUCT IS DESIGNED FOR OUTDOOR USE ONLY. Improper installation, adjustment, alteration, service or maintenance can cause property damage, injury or death.
6. Read this manual thoroughly before installation, use, or servicing of this product.



DANGER

IF YOU SMELL GAS

1. Shut off all gas supply lines to the grill.
2. Extinguish any open flames.
3. Carefully open the lid. Remember, it may be extremely hot!
4. If odor continues, keep everyone away from the grill and immediately call your gas supplier or your fire department.



DANGER

S'IL YA UNE ODEUR DE GAZ:

1. Coupez l'admission de gaz de l'appareil.
2. Eteindre toute flamme nue.
3. Ouvrir le couvercle.
4. Si l'odeur persiste, éloignez-vous de l'appareil et appelez immédiatement le fournisseur de gaz ou le service d'incendie



WARNING

1. DO NOT store or use gasoline or other flammable vapors and liquids in the vicinity of this or any other appliance
2. An LP cylinder not connected for use shall not be stored in the vicinity of this or any other appliance.



AVERTISSEMENT

1. Ne pas entreposer ni utiliser de l'essence ni d'autres vapeurs ou liquides inflammables dans le voisinage de l'appareil, ni de tout autre appareil.
2. Une bouteille de propane qui n'est pas raccordée en vue de son utilisation, ne doit pas être entreposée dans le voisinage de cet appareil ou de tout autre appareil



WARNING: CALIFORNIA PROPOSITION 65

1. The burning of gas cooking fuel generates some by-products which are on the list of substances which are known by the State of California to cause cancer or reproductive harm.
2. California law requires businesses to warn customers of potential exposure to such substances. To minimize exposure to the substances, always operate this unit according to the use and care instructions found in this manual. Be certain to provide adequate ventilation when cooking.

WARNINGS



WARNING

1. Always maintain the required clearances from combustible construction as detailed. The grill is designed for outdoor use only. Never use in a garage, building, shed, breezeway or other enclosed area. This grill shall not be used under any unprotected overhead combustible construction.
2. Gas grills are not design certified for and are not to be installed in or on recreational vehicles, portable trailers, boats or any other moving installation.
3. Keep any electrical supply cord and the fuel supply hose away from any heated surfaces. Electrical cords should be placed away from walkways to avoid creating a tripping hazard.
4. Do not repair or replace any part of the grill unless specifically recommended in this manual. Other service should be performed by a qualified technician.
5. All gas lines must have a shut-off that is readily and easily accessible. Be sure the owner knows where the shut-off is located. If you smell gas, check for gas leaks immediately. Check only with a soap and water solution. Never check for gas leaks with an open flame. (See: "Leak Testing" for further details.)



WARNING

1. The outdoor cooking gas appliance and its individual shutoff valve must be disconnected from the gas supply piping system during any pressure testing of that system at test pressures in excess of 0.5 psi (3.5 kPa).
2. The outdoor cooking gas appliance must be isolated from the gas supply piping system by closing its individual manual shutoff valve during any pressure testing of the gas supply piping system at test pressures equal to or less than 1/2 psi (3.5 kPa).



STATE OF MASSACHUSETTS

1. Massachusetts requires all gas be installed using a plumber or gas fitter carrying the appropriate Massachusetts license.
2. All permanently-installed natural gas or propane installations require a "T" handle type manual gas valve be installed in the gas supply line to this appliance.
3. This does not apply to portable propane installations using a 20 pound cylinder.

TABLE OF CONTENTS

WARNINGS	4
USE&CARE GUIDELINES	4
CUTOUT SPECIFICATIONS	9
BEFORE YOU START	7
IF SHIPMENT ARRIVES DAMAGED	7
IMPORTANT NOTES	7
BUILT-IN INSTALLATION	7
CLEARANCE TO COMBUSTIBLE MATERIALS	8
UNPACKING & ASSEMBLY	9
GAS CONNECTIONS	10
Natural Gas	10
LP Gas	11
GAS LINE PURGING	12
GAS CONVERSION KITS	12
ELECTRICAL CONNECTIONS	14
FINAL CHECKS	15
Leak Test Procedure	15
SAFETY CHECKLIST	16
PRE-GRILL CHECKLIST	17
IMPORTANT SAFETY PRECAUTIONS	18
BASIC GRILLING	19
CLEANING YOUR GRIDDLE	20
TROUBLESHOOTING	21
POTENTIAL PROBLEMS	21
CONTACTING CUSTOMER CARE	23
WIRING DIAGRAM	24

USE & CARE GUIDELINES

This use & care manual covers the Lynx grill models listed below. Some features and options will vary based upon the model that you purchased.

LYNX GRILL MODELS

<u>BUILT-IN</u>	<u>FREESTANDING</u>
L30AG	L30AGF



CUTOUT SPECIFICATIONS

W (Width)	H (Height)	D (Depth)
29.0	10.88	24.5

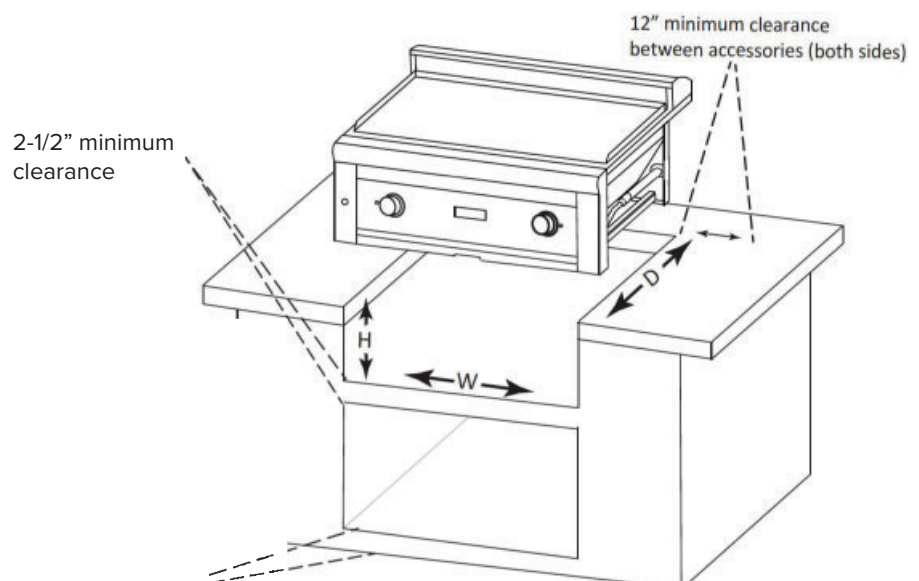

BEFORE YOU START



WARNING

- Never install this product into a combustible enclosure without an insulated jacket. Doing so could result in fire, property damage and personal injury.
- Never locate the grill under an unprotected roof or overhang, in a building, garage, shed or other such enclosed area.
- Never locate the grill under unprotected combustible construction.
- Installation must conform with local codes or, in the absence of local codes, with either the National Fuel Gas Code, ANSI Z223.1/NFPA 54, Natural Gas and propane Installation Code, CSA B149.1, or Propane Storage and Handling Code, B149.2, in Canada.

IF SHIPMENT ARRIVES DAMAGED

VISIBLE LOSS OR DAMAGE

Be certain any visible damage to the carton is noted on freight bill or express receipt and signed by the person making delivery. FILE CLAIM FOR DAMAGES IMMEDIATELY, regardless of extent of damage.

CONCEALED LOSS OR DAMAGE

If damage is unnoticed until the grill is unpacked, notify the transportation company or carrier immediately and file a “concealed damage” claim with them. This should be done within (5) days of the date delivery is made to you. Be sure to hold on to the container for inspection. We cannot assume responsibility for damage or loss incurred in transit. (See: “Obtaining Service from Lynx” for further details.)

IMPORTANT NOTES

HOW LONG IS YOUR RUN?

Keep all gas supply lines as short as possible because gas lines lose pressure over distance and with each elbow and tee that is added. This drop in pressure affects grill performance. (See: “Gas Supply Line Runs” for further details.)

ARE YOU “ON THE LEVEL”?

Proper leveling during installation is critical. A grill that is out of level will cause erratic burner combustion and inefficient, uneven heating. A carpenter’s spirit level should be used to level the grill both front-to-back and side-to-side.

BUILT-IN INSTALLATIONS

The Lynx Built-In Grill is designed for easy installation into masonry enclosures.

NOTE: Lynx built-in grills are intended either for installation in a built-in enclosure constructed of non-combustible materials or for an installation in a built in enclosure constructed of combustible material when installed with a Lynx insulating jacket (LIJ).

For non-combustible applications, the grill drops into the opening shown in the cutout detail drawing (See: “Gas Requirements”) and hangs from its counter-top trim. A deck is not required to support it from the bottom.

When using the insulated jacket in a combustible enclosure, the jacket must be supported from the bottom by a ledge on each side or a full deck beneath the jacket.

(See: "Gas Requirements") Pay special attention to the provisions shown for gas line hook-up.

The enclosure should have ventilation holes to prevent gas build-up in the event of a leak. The deck ledges and counter should be flat and level. (refer to ANSI Z21.58 Standard for Outdoor Cooking Gas Appliances, Section 1.7 Enclosures For Self Contained LP-Gas Supply Systems).

This grill requires that a 120 volt, 60 hertz, 15 amp GFI certified outlet be installed by a qualified electrician.

BEFORE YOU START *con't*

CLEARANCE TO COMBUSTIBLE MATERIALS

Minimum clearance from the sides and back of the grill to adjacent combustible construction below the counter top surface is 12" from the sides and back.

Degagement minimal entre /es parois /aterales et l'arriere de l'appareil et la construction combustible au-dessous du panneau superieur de l'appareil (30 cm a partir des parois laterales et 30 cm a partir de l'arriere).

Minimum clearance from sides and back of grill to adjacent combustible construction extending above the counter top surface is 18" from the sides and back.

Degagement horizontal minimal entre /es parois laterales et l'arriere de l'appareil et la construction verticale combustible au-dessus de l'appareil (45.7 cm a partir des parois laterales et 45.7 cm a partir de l'arriere).

Do not use this appliance under unprotected overhead combustible surfaces.

N'utilisez pas cet appareil sous des surfaces inflammables nonprotegees.

If the grill is to be placed into a combustible enclosure, an approved insulated jacket is necessary and is available only from your Lynx dealer. Lynx insulated jackets have been designed and tested specifically for your Grill.

REAR HOOD CLEARANCE

A 3 inch clearance is required behind the grill to allow the griddle plate to open fully.

The grill exhausts combustion products and cooking greases to the back. Never locate the grill where this exhaust will be difficult to clean.

OVERHEAD PROTECTION AND EXHAUST REMOVAL

If installed under any combustible construction the cooking area over the grill must be covered with an exhaust hood. The hood must provide 3" of overhang on all exposed sides. The exhaust hood shall provide no less than 1,200 CFM for proper exhaust ventilation. The hood must be approved for outdoor installation and provided with a dedicated GFCI protected branch circuit.

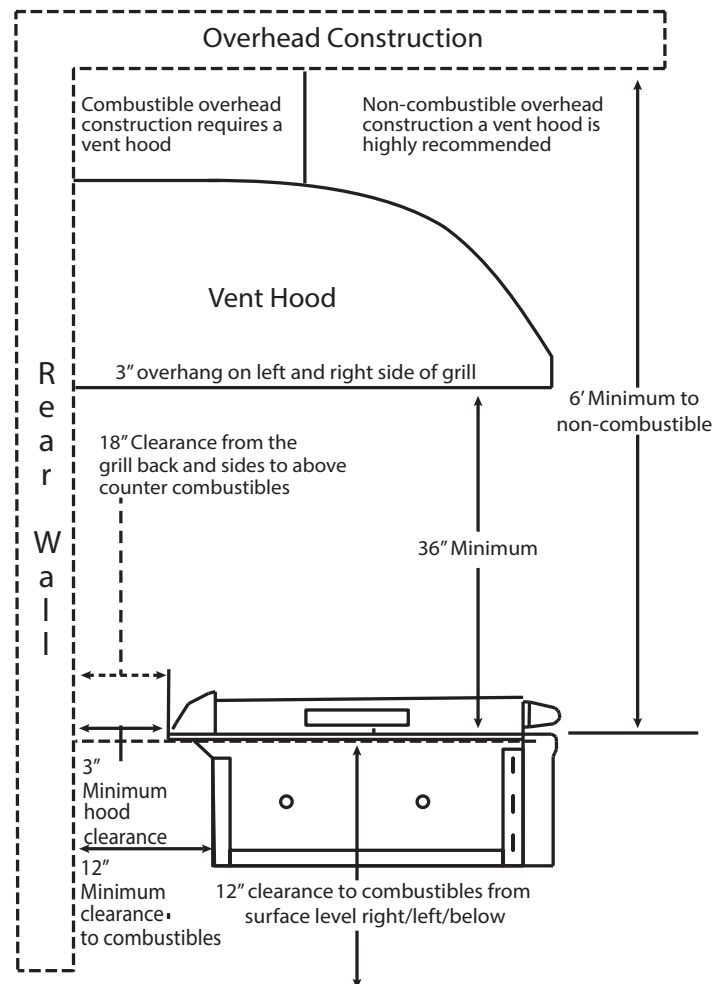

UNPACKING & ASSEMBLY

The grill arrives nearly ready to use and requires only minor assembly.

By carefully following the uncrating and unpacking steps, you will improve the customer's first Lynx experience.

Shipping weight on smaller units is app. 300 pounds and larger units may weigh over 500 pounds.



WARNING EXCESSIVE WEIGHT HAZARD

Use two or more people to move or install this unit. Failure to follow this instruction can result in back or other personal injuries.

CRATE & CARTON

IMPORTANT! Do not remove staples around the top of the carton. These staples hold a wooden pallet in place inside the carton that protects the unit from damage. Removing these staples may cause the pallet to fall on the top of grill.

How to Remove the Carton

- Cut the main strap holding the grill to the pallet.
- Remove the staples at the bottom of the carton.
- Liftoff the carton. There is a pallet over the grill for hood protection.
- With assistance, remove the grill from the pallet and place into desired location.

The wheels sit down in the gaps of the shipping crate so that the grill can sit safely and solidly on the crate during shipping. The grill cannot be slid directly off of the pallet.

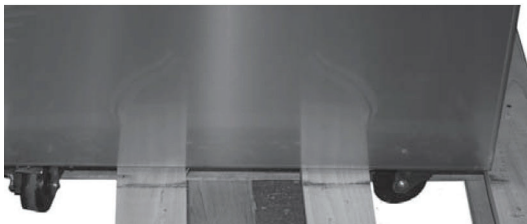

One way to safely move the grill off of the pallet is by lifting one end of the grill high enough to place a ramp under the wheel and then lift the other end while rolling the grill off of the pallet.

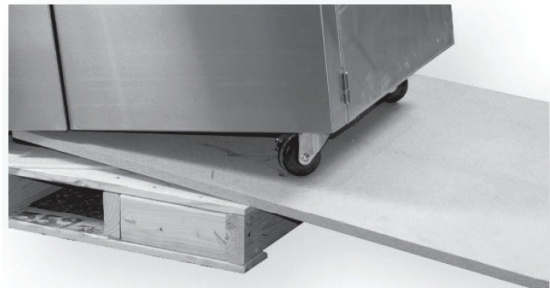

When pushing, lifting, or pulling a freestanding Lynx Grill across gravel, grass, pavers, brick, stone, imperfections in the surface, or wood slatted decks be cautious and move slowly or use a carpet dolly. Failure to do so may damage the structure of the cart which will not be covered under warranty.

INTERIOR PACKING

Lynx uses sturdy tie-down cables and straps to ensure your grill arrives at your home in the same condition that it left our factory. **BE SURE YOU HAVE REMOVED ALL TIE DOWNS BEFORE USING YOUR GRILL.**

- Cut and remove ties from the burner partition of the Trident™ burner.
- Ensure that all burners are properly seated on the burner valve orifice and sitting level with the legs in the frame slots and no side-to-side movement.

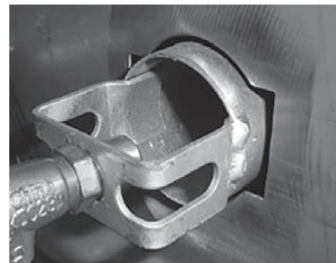
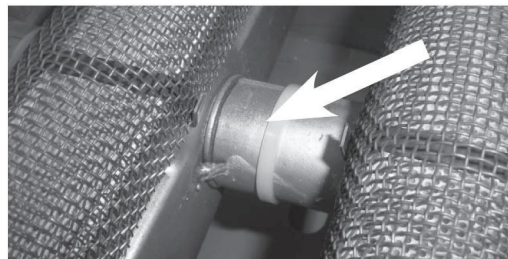

GAS CONNECTIONS



WARNING

NEVER CONNECT A GAS LINE DIRECTLY TO THE GRILL. A PRESSURE REGULATOR MUST BE INSTALLED ON ALL GAS EQUIPMENT. ALL LOCAL CODES REQUIRE IT AND LYNX SUPPLIES THE CORRECT REGULATOR WITH YOUR GRILL. REMOVING OR FAILING TO INSTALL THE PRESSURE REGULATOR CAN RESULT IN FIRE AND SERIOUS PERSONAL INJURY AND WILL VOID THE WARRANTY

The grill is factory set to use either propane (LP) or natural gas (NAT). It is critical that the gas you use matches that which the grill was set up for. You can verify that by checking the rating plate

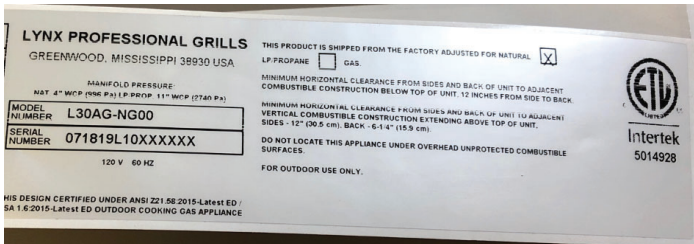

The Rating plate lists serial numbers, model numbers and gas type . This one is underneath the drip tray.

The rating plate is located in one or more of the following places:

- Attached to the underside of the stainless steel cover
- On the care and use manual

Ensure that the gas supplied meets with the minimum pressure requirements. Do not operate the grill on any gas other than that for which the grill has been set.

Fuel	WC Max Inlet	WC Min Under Full Load
Nat Gas	10 in	4 in
LP	14 in	11 in

Water Column Requirements

Both the regulator and the manifold orifices have been tuned for the type of gas specified on the rating plate.

Converting to a different type of gas requires a conversion kit, available from Lynx or from your dealer and must be installed by a qualified technician or certified plumber.

All installation and all installation parts must conform to local codes with the National Electrical Code, ANSI Z223.1/NFPA 70 latest edition and the National Fuel Gas Code, ANSI Z223.1/NFPA54 in the U.S. and CGA-B149.1/2 in Canada.

Lynx recommends that only qualified professionals perform the required plumbing on this product.

NATURAL GAS

To ensure satisfactory performance, the gas supply line must be sized to accommodate the total BTU requirements of all the gas-fired equipment that will be connected to that line.

In no case should an inlet pipe less than 3/4" inside diameter or 1" outside diameter ever be used to connect this product.

- Calculate the total BTU output of all equipment and refer to "Gas Supply Line Runs" for allowable run distances for
 - 3/4 inch pipe. Failure to meet these minimum requirements may reduce performance of the grill and any other appliances running on that supply line.
- Always keep supply line runs as short as possible. (See: "BTU Output" for specific model outputs)
- A gas shut-off valve must be installed in an easily accessible location, away from the grill and island location by a qualified plumber.
- Keep threading compound off of the first two pipe threads to avoid having any small pieces of compound break loose and clog a burner valve or orifice. Do not use threading compound on any flare fittings.

For built-in installations, it is recommended that any flexible pipe used be kept as short as possible. (See: "Gas Connections" for typical permanent hook up.)

Keep last two threads clean



GAS CONNECTIONS *con't*

For freestanding units using natural gas, Lynx recommends using a mobile flex gas line. Always keep the line away from the firebox.

This is available at your local hardware store or from your dealer.

LP GAS

Grills set up for LP gas come equipped with an LP hose/regulator assembly for connection to a standard 20 lb. LP cylinder. (Type 1). All fittings necessary to attach the assembly to the grill are included.



LP cylinder with type 1 valve connection

Permanently plumbed LP connections, such as those in line with a bulk cylinder, require a 4/11 regulator. (Lynx P/N 30781)

When using the 4/11 regulator you must ensure that it is set for the proper fuel type. This is done by removing the regulator cap and gasket and looking at the bottom of the plunger to see what fuel type is visible. This is the regulator fuel setting. NAT is for natural gas and LP is for propane gas. The LP setting can be further identified by the large diameter disk on the bottom of the plunger. To change from one gas to the other simply push the plunger to the side to snap it out of the cap, turn the plunger so it reads the desired gas type on the bottom, and push the plunger until it snaps back into place in the cap then replace the cap into the regulator.

Never connect an unregulated gas line to the grill.

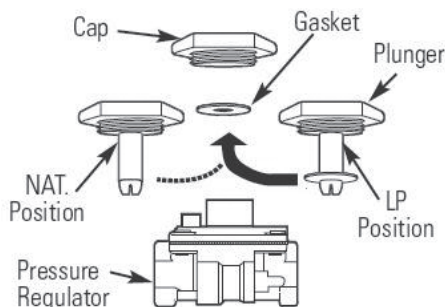

WARNING

Do not change the regulator/hose assembly or use any other assembly than the one supplied with your Lynx grill.

Do not attempt to use a SLP-A equipped regulator/hose assembly with a standard 510 POL cylinder/valve assembly.

Do not store a spare LP-gas cylinder under or near this appliance.

Never fill the cylinder beyond 80 percent full. If the information above is not followed exactly, a fire causing death or serious injury may occur.

LP CYLINDER REQUIREMENTS

The LP cylinder must be constructed and marked in accordance with the specifications for LP gas cylinders of the U.S. Department of Transportation (DOT) and designed for use with a Type 1 system only.

Cylinders of free standing grills must be secured using the provided cylinder retention system to avoid accidental movement.

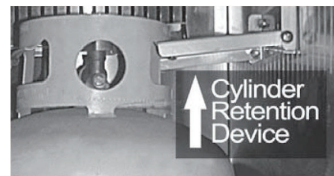

When exchanging your cylinder for a refill, exchange only for a Type 1 2016 cylinder with an over-fill protection device.

Never use a cylinder with a damaged valve.

Always check for leaks after every LP cylinder change. (See : "Leak Test" for further details.)

Cylinders must be stored outdoors in a well-ventilated area out of the reach of children. If your grill is stored indoors, the LP cylinder must be stored outside.

GAS CONNECTIONS *con't*

Insert the regulator inlet into the cylinder valve and turn the black coupler clockwise until the coupler is hand tight. Do not over-tighten this connection.

To disconnect the coupler, first make sure the main cylinder valve is turned off. Grasp the coupler and turn counter clockwise. The inlet will then disengage.

Always leak-test the connection after refilling or exchanging LP cylinders. (See "Leak Test" for further details.)

GAS LINE PURGING

You should purge the gas line of air before attempting to light the grill.

- Make sure all grill controls are in the "OFF" position.
- Slowly turn on the main gas supply.
- Wait about 20 seconds to allow the air in the system to purge and the burner to light
- Wait at least 5 minutes after shutting off the control before attempting to light the burners.

NG AND LP BUILT-IN INSTALLATION

- Shutoff the gas supply at the main valve.
- If connecting to a bulk propane tank, disconnect the brass elbow, hose and regulator from the grill.
- Remove all the fittings from the grill manifold.
- Connect the gas supply to the grill as shown in the diagram on this page.
- Turn the gas supply on and leak test all connections. (See: "Leak Test" for further details.)

Never run flex hose behind the firebox, run the hose at an angle, straight down, or out of the back.

*Call Lynx for an inline regulator if using bulk propane

GAS COVERSION KITS

Gas conversion kits are available from Lynx Grills to allow the grill to operate on either Natural gas or LPG. These kits should be installed by a qualified technician or certified plumber.

The kits come with complete installation instructions. These instructions should be read completely and fully understood before installing the conversion kit.



LP CONVERSION KIT

NG CONVERSION KIT

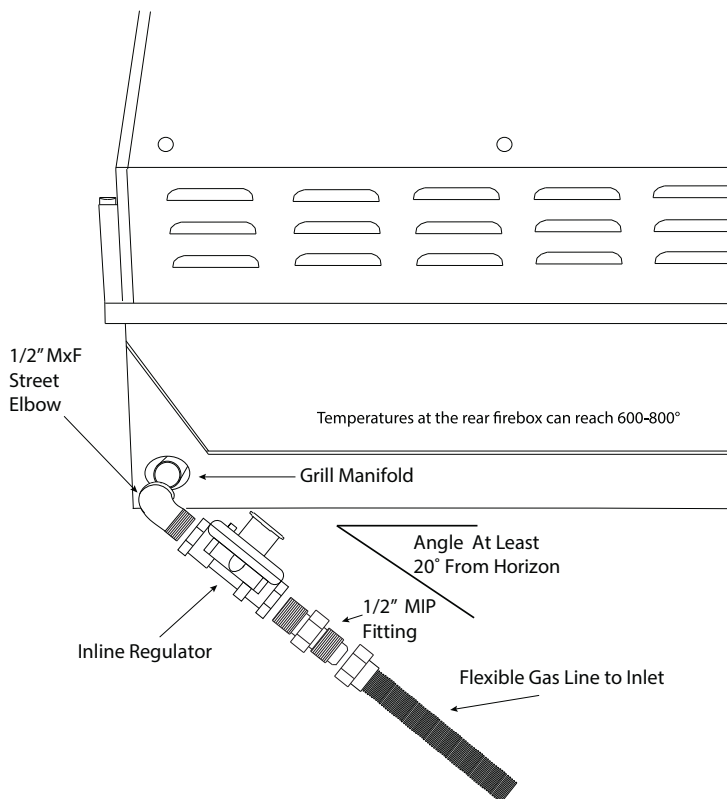

GAS CONNECTIONS *con't*

NG AND BULK LP* CART INSTALLATION

- Shutoff the gas supply at the main valve.
- Disconnect all plumbing (if already attached) from the grill and the gas supply valve.
- Remove all the fittings from the grill manifold if necessary.
- Connect the gas supply to the grill as shown in the diagram on this page for your gas type.
- Turn the gas supply on and leak test all connections. (See: "Leak Test" for further details .)

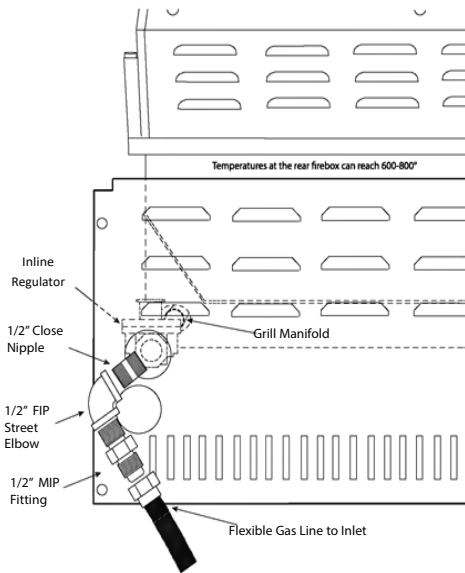
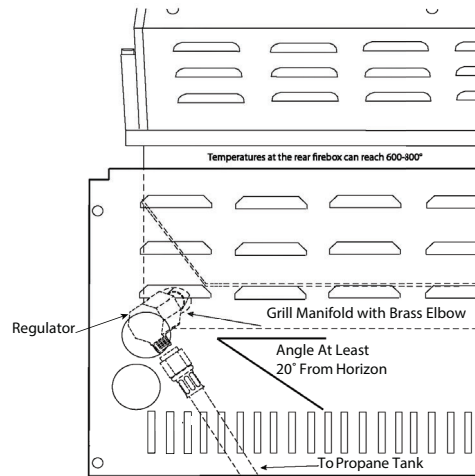

LP BOTTLE CART INSTALLATION

- Shutoff the gas supply at the main valve.
- Connect the gas supply to the grill as shown in the diagram on this page for your gas type .
- Turn the gas supply on and leak test all connections. (See: "Leak Test" for further details.)

SIDE BURNER INSTALLATION

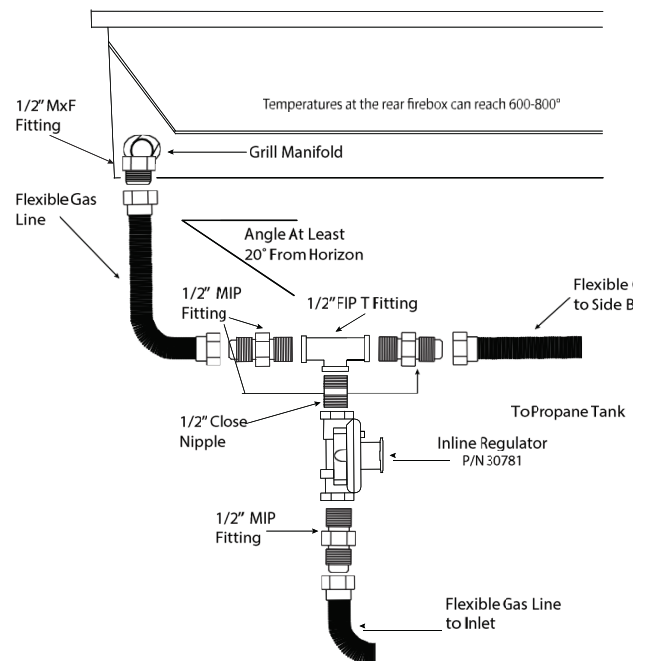
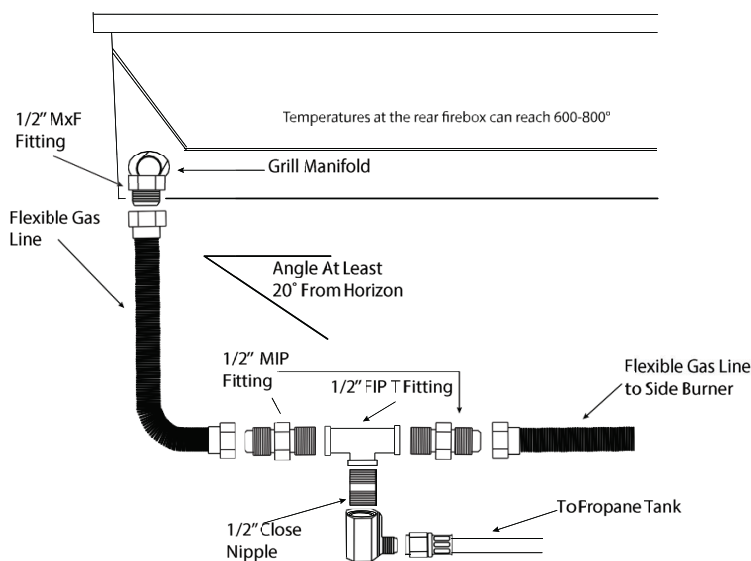

ELECTRICAL CONNECTIONS



WARNING: ELECTRICAL GROOUNDING

- Product installation must meet local electric codes or, in the absence of local codes, the latest edition of the National Electrical Code ANSI/NFPA No. 70 or the Canadian Electrical Code CGA 1.662005.
- Use only a Ground Fault Interrupter (GFI) protected circuit with this outdoor cooking gas appliance.
- Do not use this outdoor cooking appliance if it has been submerged under water without thorough inspection by a qualified technician.
- This grill is equipped with a three prong (grounding) electric plug for your protection against shock hazard and must be plugged directly into a properly grounded three prong outlet. Never cut or remove the grounding prong from this plug.
- Use only extension cords with a 3 prong grounding plug, rated for the power of the equipment, and approved for outdoor use with a “W-A” marking.
- To protect against electric shock, do not immerse any part of the power cord, an extension cord or any plugs in water or other liquid.
- Unplug the product from the outlet when not in use and before cleaning. Allow it to cool before putting on or taking off parts.
- Do not let the cord hang over the edge of a table or touch hot surfaces.
- Do not use an outdoor cooking gas appliance for purposes other than intended.
- Do not operate any outdoor cooking gas appliance with a damaged cord, plug, or after the appliance malfunctions or has been damaged in any manner. Contact the manufacturer for repair.

CONNECTION TO AC

Installation requires an outdoor 120VAC 15A GFI (Ground Fault Interrupter) electrical outlet adjacent to the grill.

The GFI outlet features an internal breaker that reduces shock hazard. This type of outlet should be installed by a qualified electrician either inside the island enclosure for built-in units, or near the location where a free-standing unit will be used.

If the electrical system fails to operate, a connection may have come loose in shipping or the GFI may have tripped, requiring a reset. See the Troubleshooting section for more details.

FINAL CHECKS



DANGER

To prevent fire or explosion hazard, DO NOT smoke or allow any potential source of ignition (sparks, electrical arcing, etc) in the area while performing a leak test. Leak tests should be conducted outdoors only. Never conduct a leak test using fire or flame.

LEAK TEST PROCEDURE

- Create a soapy solution of 1 part soap and 3 parts water.
- Confirm that all control knobs are in the off position.
- Turn on the fuel supply. For natural gas, turn the valve handle 1/4 turn to align with the gas flow.
- For L.P., turn the cylinder valve knob counter clockwise one full rotation.
- Apply the soap solution generously by paint brush or squirt bottle on all connections and fittings.
- If bubbles appear to "grow" on any of the connections, you have a gas leak. IMMEDIATELY turn off the gas supply.

FIXING A GAS LEAK

- Shutoff the gas supply
- Turn all grill controls to the "ON" position to purge the grill of any gas build-up, then turn the controls back "OFF".
- Wash off the soapy solution with cold water and dry.
- Tighten the loose joint, or replace the faulty part with manufacturer-recommended replacement parts.
- DO NOT attempt to repair the L.P. cylinder valve if it is damaged. The only way to safely resolve a damaged cylinder is to REPLACE IT.
- Repeat the leak test to ensure that no leaks are present.

NOTE: The Trident TM does not have an air shutter.

The appearance of the Trident TM burner should be visually checked. The ceramic tiles should be uniformly red to orange in appearance. There should be no lifting, fluttering or lazy blue flames.

IMPORTANT:

Make sure the owner knows where the main gas supply shut off valve is located.

Before leaving, check all the burners for proper operation. Make sure the control knobs turn freely and completely through their full range.

Finally, for safety and for proper use & care, you must leave this manual with the owner. Make sure you advise them to keep it for future reference.

For technical assistance call:

Lynx Customer Care
888-289-5969

SAFETY CHECKLIST

- Do you smell gas? If yes, shut off everything and call the gas company or a qualified plumber to check for leaks, if not please continue.
- Are you prepared to stay with the grill during the entire cooking process? If not, gather what you need before starting the lighting process. If yes, please continue.
- Is your cooking area free and clear of any combustibles, besides your food, that might ignite? If not, clear the area before starting the lighting process, If yes, please continue
- Do all control knobs turn freely? If not, call for service, if yes, please continue.
- If you are using a portable propane cylinder, is it connected and leak tested? If not, check the connection before continuing. If yes, please continue.
- Do you know where your grill's main gas supply shut off valve is located? If not, locate it before continuing. If yes, please continue.
- Are all burners properly seated in the grill with mounting legs in slots? If not, seat the burners properly before continuing. If yes, please continue.
- Is the wind blowing just lightly and not blowing on the back of the grill? If not, wait until the wind subsides or turn your free standing grill so the wind goes into the front of the grill. If yes, please continue with the lighting process.

A MESSAGE TO OUR CUSTOMERS

You've just joined the world of Lynx cooks ... a discriminating collection of amateur and professional chefs that take outdoor cooking to a new level.

Your grill has been designed and built with meticulous attention to detail and it offers some unique and powerful features. You can achieve maximum performance and enjoyment of these features only by carefully reading this manual ... before your first cook-out.

This manual includes important safety tips and great hints for better grilling. You'll want to keep it handy for easy reference.

Also, at Lynx, we enjoy hearing from our customers. We like to hear about your successes but also about any difficulties you are having. Please feel free to contact us with any questions or problems, or just to share a new recipe. Please include the model number of your grill in your correspondence.

With the proper use and care this product will provide years of trouble-free service.

Should your Lynx grill change ownership, please make sure that the new owner receives this manual.

Thanks again for your purchase. Enjoy!



PRE-GRILL CHECKLIST



COLD WEATHER WARNING: PROPANE

Extremely cold temperatures may cause your Trident™ burners to light inside the burners instead of outside. Once lit, if you hear a 'whooshing' sound, immediately turn the burner knobs off to extinguish the flame and then immediately re-light the burners.

BEFORE YOUR FIRST USE

There are a few must-check safety precautions to consider before you use your grill. Please be sure that:

- All packing materials and tie-downs have been removed from the burners. (See: "Unpacking & Assembly" for further details.)
- You have fuel connected. (See: "Gas Requirements" for further details.)
- You have electric connected. (See: "Electric Requirements" for further details.)
- A qualified plumber has performed a leak test on all the fittings that supply fuel to your grill.

AT EACH NEW SEASON

At the start of each new grilling season you should check the burners, venturis, orifices and valves for obstructions. Spiders and insects often nest in these areas of the grill and can disrupt air flow, causing damage to the grill and personal injury.

Also, check all hoses and fittings for damage, abrasion, wear and tear.

LIGHTING YOUR GRILL



WARNING

1. Never attempt to light a burner if you smell gas.
2. NEVER LEAVE THE GRILL UNATTENDED WHILE THE GRILL IS LIT.

ELECTRIC IGNITION

1. Before each use, complete the checklist above.
2. Remove the cover.
3. Make sure all burner control knobs are in the OFF position.
4. Push in the power/shut-off button. The blue LED lights above the knobs will indicate that the grill is energized.
5. Turn the knob to the desired position. The blue burner indicator light will glow when the burner is on. The blue burner indicator light will shut OFF when the burner temperature set point is met. The blue light will cycle blue ON/OFF during normal operation. The blue LED light above the knobs will indicate that the grill is on.



IMPORTANT SAFETY PRECAUTIONS

PLEASE REVIEW THESE IMPORTANT SAFETY PRECAUTIONS BEFORE YOU USE YOUR GRILL.

1. NEVER LEAVE THE GRILL UNATTENDED WHILE COOKING
2. Ensure all zip ties have been removed from the burners.
3. Avoid wearing loose-fitting garments or long sleeves while grilling. They could ignite.
4. Never touch the grill surface or immediate surrounding metal surfaces with your bare hands while grilling.
5. Use an insulated glove or mitt when operating the grill.
6. Do not heat unopened food containers as pressure build-up will cause the container to explode.
7. Inspect the LP hose before each use. If the hose shows excessive wear or abrasion, or the hose is cut it must be replaced with a hose assembly available from Lynx Grills.
8. Never use charcoal or any other solid fuel in the grill.
9. Cooking excessively fatty meats and oils will cause splattering. Any damage caused as a result or by the grill being left unattended while cooking are not covered under the terms and conditions of our warranty.
10. Never grill without the drip pans in place. Always ensure the drip pan is pushed all the way to the back of the grill. Hot grease can leak downward and produce a fire or explosion.
11. Grease is extremely flammable. Let hot grease cool down before attempting to handle or dispose of it. The drip tray should be cleaned of grease on a regular basis.
12. Do not use the grill unless a leak check has been performed on all gas connections. (See: "Leak Test Procedure" for further details.)
13. Never operate the grill while under the influence of alcohol or drugs.
14. Do not lean on side shelves and never place a load weighing more than 25 pounds on a side shelf.
15. If any burner does not light or goes out during operation, turn off all gas control knobs, and wait five (5) minutes before attempting to re-light.
17. Portable L.P. cylinders: Always shut off the main valve on the L.P. cylinder after each use. Spiders and insects like to nest in the burners, venturis, valves and orifices of a grill, disrupting the gas flow. This very dangerous condition can cause a fire behind the control panel, damaging the grill and risking personal injury. If your grill has been unused for a long time, inspect and clean the burners, venturis, valves and orifices.



WARNING

DO NOT LEAVE THE GRILL UNATTENDED DURING THE PRE-HEAT CYCLE OR AT ANY TIME WHILE THE GRILL IS IN USE.



WARNING

DO NOT ALLOW EXCESS GREASE OR LIQUIDS TO ACCUMULATE IN THE DRIP TRAY AS THIS MAY CREATE A FIRE HAZARD. NEVER USE GRILL WITHOUT DRIP TRAY PROPERLY INSTALLED.

BASIC GRILLING

PRE-HEATING

Pre-heating your grill every time you use it is extremely important. Pre-heating allows the griddle to properly heat up, providing more even and more consistent cooking results.

Pre-heat your grill by igniting all main burners, and setting them to the desired cooking temperature.

NOTE: Only heat the grill to the maximum setting when you plan on cooking at that temperature. Once heated, the grill will retain heat for long time. Set the temperature for your desired food items. The temperature controller indicator lights will turn off when the grill reaches the temperature set point.

COOKING ON THE GRIDDLE PLATE

1. Push in the Power/Shutoff button. The BLUE burner knob lights will show that the grill is energized
2. Turn the knob clockwise to the desired position. The indicator lights will glow until the grill reaches the temperature set point. The indicator lights and burners will cycle OFF and ON under normal operation to maintain the temperature setting.

SETTINGS	
LOW	100°F
MED LOW	150°F
MEDIUM	225°F
MED HIGH	300°F
HIGH	375°F
MAXIMUM	450°F

FOOD	SETTING
Eggs	325°F - 350°F (160°C - 180°C)
Bacon, Breakfast Sausage	425°F - 452°F (220°C - 230°C)
Toasted Sandwiches	375°F - 400°F (190°C - 200°C)
Boneless Chicken Breasts	425°F - 452°F (220°C - 230°C)
Boneless Pork Chops 1" (2.54 cm) thick	425°F - 452°F (220°C - 230°C)
Steaks 1" (2.54 cm) thick	425°F - 452°F (220°C - 230°C)
Ground Beef Patties 6 ozs	425°F - 452°F (220°C - 230°C)
Ground Turkey Patties 6 ozs	425°F - 452°F (220°C - 230°C)
Hot Dogs	350°F - 375°F (180°C - 190°C)
Ham Slices 1/2" (1.27 cm) thick	350°F - 375°F (180°C - 190°C)
Pancakes, French Toast	400°F - 425°F (200°C - 220°C)
Potatoes, Hash Browns	400°F - 425°F (200°C - 220°C)
NOTE: The use of pots and pans is not recommended as they may discolor the cooktop	

CLEANING YOUR GRILL *(Including Required Maintenance)*

STAINLESS STEEL

Lynx products are known for their attractive appearance. We achieve this by selecting only the finest grades of stainless steel and applying exacting workmanship. In order to maintain this attractive appearance over the life of the grill it is important to take the following steps:

- After each use wipe down the exterior of the grill to remove grease and splatters.
- Be sure to follow the cleaning instructions for keeping the grates and burners clean and ready for use.
- Use a commercially available Stainless Steel cleaner* to clean and polish the exterior surfaces.

Doing these things on a regular basis minimizes the amount of effort required.

Part of the appeal of your Lynx Grill is the fine grain finish. When removing stubborn stains:

- Do not use metallic abrasives and always rub in the direction of the grain.



- Some household cleaning products* are not suitable for stainless steel; be sure to read the label before using on your Lynx Grill.
- Always use the mildest cleaning solution first, scrubbing in the direction of the grain. Specks of grease may gather in the grain of the stainless steel and bake on to the surface, giving the appearance of rust.

To remove these baked-on foods use a fine to medium grit non-metallic abrasive pad (Scotch Brite is good) in conjunction with a stainless steel cleaner.

Solutions used for cleaning concrete and masonry can be very corrosive and will 'attack' stainless steel. Ensure your Lynx products are well protected before you allow the use of such chemicals near your grill.

SPECIAL NOTE FOR LOCATIONS NEAR POOLS AND COASTAL AREAS:

The 304 stainless steel material used in the construction of a Lynx Grill is highly rust resistant, however, chlorine in the air from swimming pools or the salt from sea air may cause surface rust to appear and even create some pitting if left on the product.

Here are a few tips to avoid this:

- Regularly wipe down the exterior surfaces with a damp cloth. (Micro fiber cloths such perform very well).
- Allow the surfaces to dry before installing the cover. Do not cover a damp grill.
- In extreme environments apply a rust inhibitor which leaves a microscopic protective layer on the grill. Products that provide a layer of vapor corrosion inhibitors (VpCI™) protect the surface very well.
- For seasonal storage use the product referred to above, ensure the grill is dry and then cover and secure the cover to minimize the amount of damp air getting to the surfaces.

THE LYNX LIMITED LIFE TIME WARRANTY PROVIDES PROTECTION AGAINST RUST THROUGH OF PARTS THAT RENDER THE PRODUCT INOPERATIVE. IT DOES NOT COVER OCCASIONAL SURFACE RUST OR STAINING DUE TO ENVIRONMENTAL CONDITIONS.

After your first use certain areas of the grill may discolor from the intense heat given off by the burners - this is normal and cannot be cleaned off.

For light and heavy food stains there are many different stainless steel cleaners available.

DRIP TRAY

The drip tray should be cleaned after each use. After the grill is completely cool, remove the drip trays by tilting forward and up, lifting them out of place.

They can be wiped down with a paper towel and placed in a dishwasher for cleaning.

*RATED FOR HIGH HEAT

PAINTED PARTS

Wash with warm soapy water. DO NOT use steel wool, abrasive cleaners, ammonia, or cleaners containing acid. This may damage the finish.

CLEANING YOUR GRILL *(Including Required Maintenance)*



WARNING

1. Failure to perform required maintenance will void your warranty.
2. Scrape the griddle plate and discard the residue.
3. Clean out the burner orifices and ensure they are free of debris.
4. Clean the drip tray.

TROUBLESHOOTING YOUR LYNX GRILL

BEFORE YOU CALL FOR SERVICE

Please check a few things before calling for service:

- Is there fuel supplied to the grill?
- Is the main shut-off valve open?
- Are you using the correct type of fuel? (LP or Natural Gas)(See: “Gas Requirements” for further details.)
- Is your propane cylinder empty? Have you recently refilled the propane cylinder? If so, is the connection tight?
- Have you opened the valve on the propane cylinder?
- Is the grill plugged in to a live electric circuit?
- If you’ve checked the above items, review the potential problems on the following pages before calling for Lynx for service.

POTENTIAL PROBLEMS

GRILL WILL NOT LIGHT

First, confirm that the grill is getting electricity by turning on the lights, then:

Check The Igniters

Your Lynx grill uses an electric ignition system that does not spark. Instead, the igniters will glow constantly when a control knob is turned ON.

Check The Burners

- Ensure that all burner controls are off.
Lift open the cooking surface.
- Turn the burner knob ON and wait approximately 1 minute for the igniter to glow.
- If the igniter fails to glow, proceed with troubleshooting.
If the igniters are working check to see if gas is reaching the burners by attempting to match light a burner.
- If match lighting doesn’t work, re-check fuel connections for leaks and ensure the supply is of the correct type and is of adequate pressure.
(See: “Leak Test Procedure” for further details.)
- If the burner will light with a match, then the igniter may not be functioning correctly. Call for service.
- If the burner will not match light, and you know you are getting gas, wait for any gas to dissipate and remove the burner and check it for blockages.

SMELL OF GAS WHILE COOKING

IF YOU SMELL GAS WHILE THE GRILL IS OPERATING, IMMEDIATELY TURN OFF ALL BURNERS AND SHUT OFF THE MAIN FUEL SUPPLY.

Perform a leak test (See: “Leak Test Procedure” for further details.)

POTENTIAL PROBLEMS *con't*

GLOW OR INSUFFICIENT HEAT

Ensure that you've preheated the Trident™ burner for at least 10-15 minutes.

Proper leveling during installation is critical. A grill that is out of level will cause erratic burner combustion and inefficient, uneven heating. A carpenter's spirit level should be used to level the grill both front-to-back and side-to-side.

If the low heat problem persists:

- Check the gas supply line sizing requirements.
- Check the gas supply line for kinks or damage. Replace any damaged supply lines.
- Check the regulator. Make sure that the regulator & hose assembly is the one designed for and supplied with your Lynx grill and that it is correctly set up for the type of fuel you are using. (See: "Regulator Conversion" for further details.) The hose and regulator provided by Lynx must be used if your grill is set-up for a portable LP Gas Cylinder. Ensure the LP hose is not behind the firebox. Check that there is no physical pressure being applied to the regulator attached to the back of the grill. The regulator contains a flexible diaphragm and should not be allowed to touch the grill body or its surroundings.
- Check for Obstructions. Ensure that the burners and drip tray are clean and free from obstructions.

LP (Propane) units:

- Is the cylinder almost empty? Almost-empty cylinders may not have sufficient pressure to run the burners at high heat.
- Have the line pressure checked by a qualified technician (See: "Gas Requirements" for further details.)
- Flow Limiting Device. Improper lighting procedures may have activated the LP cylinder's flow control device, reducing the heat output.

To reset the flow control:

- Shut off all burner controls and close the LP cylinder valve.
- Wait 30 seconds and, very slowly, reopen the cylinder valve.
- Wait a few seconds and relite a burner.

Bulk LP cylinder users:

- Bulk LP cylinder lines must be properly regulated.
- Ensure that you are using a 4/11 appliance regulator supplied by Lynx and converted to LP gas. Also ensure that you do not have more than one regulator in line.

Natural Gas units:

- Supply Line. Ensure that the supply line is at least 3/4" inside diameter or 1" outside diameter.
- Check line pressure. Natural gas inlet pressure should be at least 7" W.C. and manifold pressure not less than 4" W.C. under full load (with all burners on.)
- Check burners for blockages.

LIGHTS WILL NOT ILLUMINATE

- Check Power. Ensure that the grill is connected to a live AC power source and check for rotisserie motor operation.

If the grill is connected to live AC power and lights will not illuminate, contact service.

CONTACTING CUSTOMER CARE

Before calling Lynx Customer Care, please make sure you have the following information:

- Model number
- Date of purchase
- Proof of purchase by the original owner
- Serial number

The serial number can be located on the rating plate which is located on the underside of the stainless steel cover and on the care and use manual.

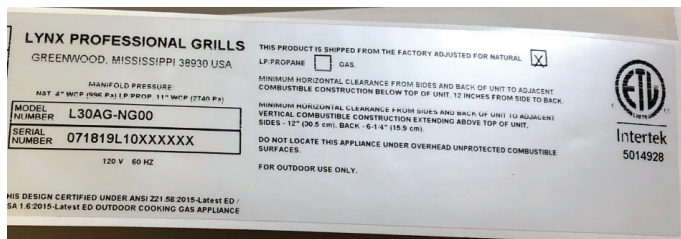

For warranty service, contact the Lynx Customer Care Department for an authorized service agent near you at:

(888) 289-5969
www.lynxgrills.com

Your satisfaction is of the utmost importance to us. If a problem cannot be resolved to your satisfaction, please write, fax or email us:

Lynx Professional Grills
62201 Hwy 82 West
Greenwood, MS 38930

888-289-5969

email: service@lynxgrills.com

www.lynxgrills.com

Contact Lynx for replacement parts.

WIRING SCHEMATIC

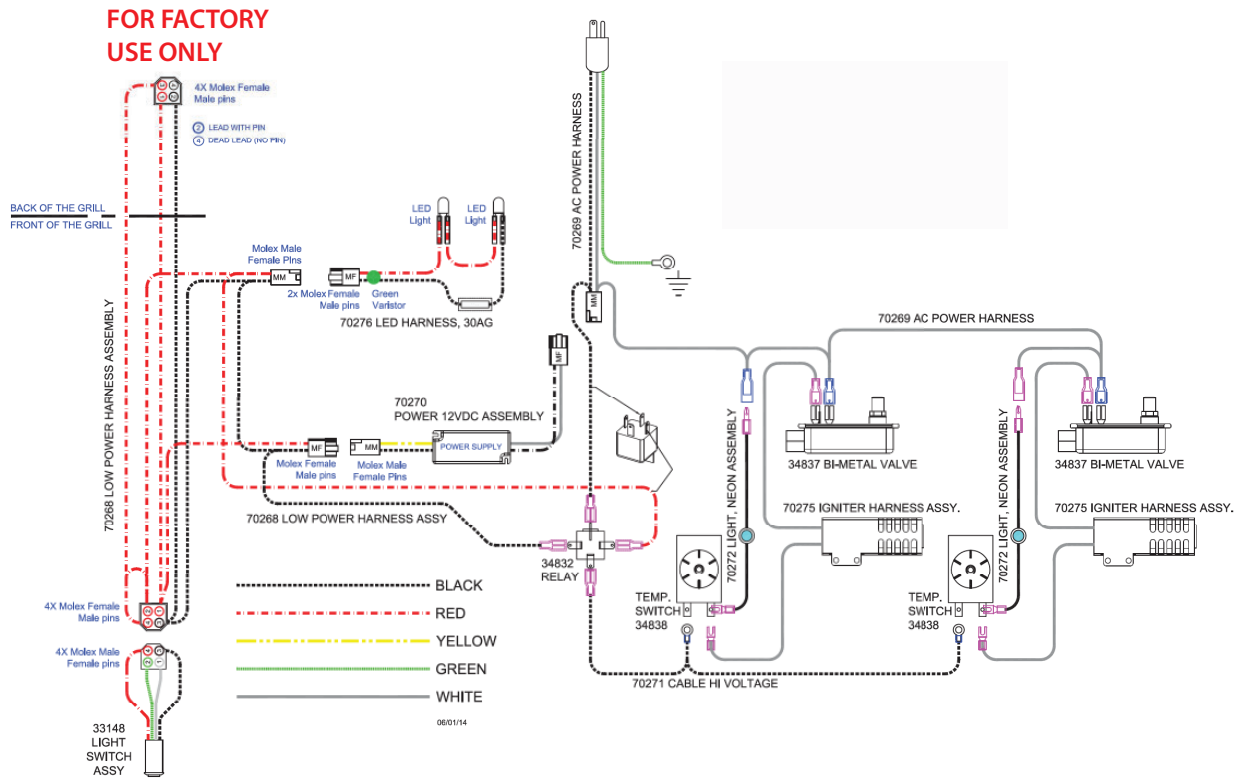

Lynx Grills, Inc.
62201 Hwy 82 West Greenwood, MS 38930
Service: (888)-289-5969
www.lynxgrills.com